

بِسْمِ اللّٰهِ الرَّحْمٰنِ الرَّحِیْمِ



ACCIDENT INVESTIGATION COORDINATING COMMITTEE

Republic of Maldives

AIRCRAFT OCCURRENCE INVESTIGATION 2021/02

FINAL REPORT

**INVESTIGATION OF THE SERIOUS INCIDENT INVOLVING
TRANS MALDIVIAN AIRWAYS OPERATED VIKING AIR DHC-6-300
8Q-MBC FLOATPLANE AT FINOLHU RESORT WATER AERODROME,
MALDIVES**

on

13 November 2021

INTRODUCTION

Maldives is a signatory to the Convention on International Civil Aviation (Chicago, 1944) which established the principles and arrangements for the safe and orderly development of international air transport. Article 26 of the Convention obligates Signatories to investigate accidents to civil aircraft occurring in their State.

This report is based upon the investigation carried out by the Accident Investigation Coordinating Committee (AICC) in accordance with Annex 13 to the Convention, the Civil Aviation Act 2/2001 and the Civil Aviation Regulations.

The sole objective of the investigation of an accident or incident is prevention of accidents and serious incidents and it shall not be the purpose of this activity to apportion blame or liability.

The AICC was assisted by Maldives Civil Aviation Authority (MCAA) and Trans Maldivian Airways (TMA).

All timings are given in Local Time unless stated otherwise. Time difference between local and UTC is +5 hours.

The report is released on 13 March, 2023.

Mr. Abdul Razzak Idris

Chairperson

Accident Investigation Coordinating Committee



CONTENTS

INTRODUCTION	2
1.0 FACTUAL INFORMATION	8
1.1 History of Flight	8
1.1.1 Background	8
1.1.2 Aircraft	9
1.1.3 Flight crew	10
1.2 Injury to persons	10
1.3 Damages to aircraft	10
1.4 Other Damage	10
1.5 Personnel information	11
1.5.1 Pilot-In-Command	11
1.5.2 Co-pilot.....	11
1.5.3 Cabin Crew	12
1.6 Aircraft Information	12
1.7 Meteorological information.....	16
1.8 Aids to Navigation	17
1.9 Communications	17
1.10 Aerodrome information.....	17
1.11 Flight Recorders.....	18
1.12 Wreckage and impact information.....	18
1.12.1 Incident site visit.....	18
1.12.2 Wreckage Condition.....	18
1.12.3 Salvage operations.....	18
1.13 Medical and pathological information.....	18
1.14 Fire.....	18
1.15 Survival Aspect.....	18
1.16 Tests and research.....	19
1.17 Organizational and Management Information.....	19
1.18 Additional Information	19
1.19 Useful or Effective Investigation Techniques.....	19

2.0	ANALYSIS.....	20
2.1	General	20
2.2	Crew Qualification and Training	20
2.3	Crew Duty Time / Sector Limitations.....	21
2.4	Weight & Balance	21
2.5	Take off path	22
2.6	Inability to Reverse.....	25
2.7	Engine Power	26
2.8	Hurry Up syndrome	28
3.0	CONCLUSIONS.....	30
3.1	Findings.....	30
3.2	Causes / Contributing Factors	30
3.3	Recommendation to all Operators.....	31
3.4	Recommendation to the Regulator	31
4.0	APPENDICES	32
4.1	Flight release documents.....	32
4.2	Aircraft Technical log	36
4.3	Engine data from G950	37
a.	(Np, Fuel flow, G Force).....	37
b.	(IAS, G Force, GPS Alt)	37
4.4	Finolhu Water Aerodrome Chart	38
4.5	Damages to aircraft and the bungalows	39
4.6	Still pics – in sequence; captured from the Video at the time aircraft came in contact with the bungalow.....	41

LIST OF ABBREVIATIONS

AICC	: Accident Investigation Coordinating Committee
AIP	: Aeronautical Information Publication
AFM	: Airplane Flight Manual
ASC	: Air Safety Circular
ATL	: Aircraft Technical Log
ATPL-A	: Airline Transport Licence - Aeroplanes
CCL	: Cabin Crew License
CCTV	: Closed circuit television
CG	: Center of Gravity
CPL-A	: Commercial Pilot Licence - Aeroplanes
CYC	: Cycles
CVR	: Cockpit Voice Recorder
DHC-6-300	: Viking Air Twin Otter 300 series aircraft
EASA	: European Aviation Safety Agency
ELT	: Emergency Locator Transmitter
EMMA	: Equalized Maintenance for Maximum Availability
FDR	: Flight Data Recorder
FIN	: Operator designated 3 letter code for Finolhu water aerodrome
FO	: First Officer
FWD	: Forward
G950	: Garmin G950 flight management system
IFTSS	: Individual Flight Time Specification Scheme
IAS	: Indicated Air Speed
ISA	: International Standard Atmosphere
Km	: Kilometer
lbs.	: Pounds
LH	: Left Hand
LOPA	: Layout of Passenger Accommodation
MACL	: Maldives Airports Company Limited
MCAA	: Maldives Civil Aviation Authority
MCAR	: Maldives Civil Aviation Regulations
MFD	: Multi-Function Display
MLE	: IATA designated 3 letter code for Velana International Airport
MMG	: Operator designated 3 letter code for Maamunaga water aerodrome
MMS	: Maldives Meteorological Service
MTOW	: Maximum Take-Off Weight

mph	: Miles per Hour
Np	: Propellor speed
OM-A	: Operations Manual Part A
OM-B	: Operations Manual Part B
PED	: Portable Electronic Device
PIC	: Pilot-in-Command
PICUS	: Pilot-in-Command under supervision
PF	: Pilot Flying
Psi	: Pounds per square Inch
PWC	: Pratt and Whitney Canada
RFR	: Operator designated 3 letter code for ReethiFaru water aerodrome
RH	: Right Hand
SOP	: Standard Operating Procedure
STC	: Supplemental Type Certificate
SD	: Secure Digital
TAC	: Total Air Cycles
TAT	: Total Air Time
TBD	: To be determined
T/O	: Take-Off
TMA	: Trans Maldivian Airways Pvt. Ltd.
UTC	: Coordinated Universal Time
VIA	: Velana International Airport
VFR	: Visual Flight Rules
WSW	: West of south west direction

SYNOPSIS

On 13 November 2021, DHC-6-300 aircraft, registration 8Q-MBC operated by TMA, was on a charter flight, from Finolhu Resort (Kanifushi island, Baa Atoll), to Velana International Airport (MLE). There were 15 (fifteen) passengers, two pilots and one cabin crew onboard the aircraft.

During take-off from the Island lagoon in a north-westerly direction, towards a stretch of water bungalows, the crew decided to abort the take-off. While aborting the take-off the crew were unable to stop the aircraft.

The crew then shut down both engines by shutting off the fuel, but under the momentum the aircraft kept moving and came in contact with two adjacent water bungalows and then came to a stop. The aircraft sustained damages to its LH wing, RH wing tip, and one of the RH propeller blades. No injuries to passengers or crew were reported.

The aircraft was towed back to the floating platform and the passengers and crew disembarked safely.

At the time of the incident strong winds and choppy seas were reported. Weather data from the nearest automatic weather station recorded wind speeds of 25 mph (21.7 knots) from WSW at the time of the incident.

The incident occurred at 17:11 hrs and the MCAA reported the incident to the Accident Investigation Coordinating Committee (AICC) at 19:04 hrs on the same day. AICC began its investigation on the following day.

1.0 FACTUAL INFORMATION

Aircraft Owner:	Trans Maldivian Airways Pvt Ltd.
Registered owner:	Trans Maldivian Airways Pvt Ltd.
Operator:	Trans Maldivian Airways Pvt Ltd. (Air Operator Certificate No.005)
Aircraft Type:	DHC-6-300
Aircraft Manufacturer:	de Havilland Canada (Type Certificate now owned by Viking Air Ltd.)
Manufacturer's Serial No.:	256
Nationality:	Republic of Maldives
Registration:	8Q-MBC
Place of Incident / Accident:	Finolhu Resort (Kanifushi Island, Baa Atoll)
Reported location:	05° 0' 48.18" N 73° 72' 57' 11.71" E
Date and Time:	13 November 2021 at 17:11 hours

1.1 History of Flight

1.1.1 Background

The aircraft was released by the Dispatch for the flight at 14:35 hrs at main base (VIA) on 13 November 2021. Prior to this multisector flight, the aircraft had flown 9 sectors earlier in the day, with the same crew. Aircraft daily inspection was carried out on 12 November 2021, and there was no record of any open deferred defects listed in the Aircraft Technical Log (ATL). The crew carried out the pre-flight and walk-around checks before the aircraft departed from Velana International Airport and no abnormalities were reported by the crew.

The aircraft was dispatched on 13 November 2021, on a multi-sector flight, (flight number FLT772157), Velana International Airport (MLE) – Maamunaga (MMG) – ReethiFaru Resort (RFR) – Finolhu Resort (FIN) and then back to MLE. The aircraft departed with 3 crew members (2 flight crew and 1 cabin crew) and 14 passengers - 4 passengers destined to MMG and the rest 10 passengers to ReethiFaru Resort. At MMG 4 passengers disembarked and no passengers joined. Hence, the second sector of the flight departed MMG with 10 passengers. At RFR all 10 passengers disembarked the aircraft and 4

passengers joined. The aircraft departed RFR, the third sector of the flight with 4 passengers. The next destination was FIN where 11 passengers (including 1 infant) joined the flight. Hence, on this fourth sector of the flight, the incident sector, departing FIN, there were 15 passengers (including 1 infant) and three crew members onboard.

The PF of the incident flight was the PIC who was seated on the right seat as it was a training flight for the other crew member. According to the flight crew, no abnormalities were observed in any of the previous flights. On the incident flight, the take-off run was longer than expected; and during the take-off run the aircraft was momentarily airborne but settled back on water shortly afterwards. The crew then decided to abort the take-off.

According to the crew, after aborting the take-off, the power levers could not be moved to reverse position. As the crew were unable to move the power levers to the reverse position, the crew decided to shutdown both engines by shutting off the fuel.

After the engines were shut down, the aircraft moved forward under momentum and came in contact with two water bungalows. As a result, the aircraft and the bungalows sustained damages. RH propeller, RH wing tip and the LH wing of the aircraft were damaged. The wooden staircases of the two bungalows were damaged.

The aircraft was towed back to the platform by a dinghy. Once the aircraft was secured at the platform all the passengers and crew disembarked safely. The baggage was offloaded afterwards. No injuries to crew or passengers were reported.

On the day of the incident flight both the PIC and the FO reported to duty at 05:30 hrs at TMA base. The PIC was reporting for the first day of duty after a three-day rest period. The FO was on the third day of his duty, after a three-day rest period. Both crew members knew each other and were paired to fly together in the past.

1.1.2 Aircraft

The DHC-6-300 series aircraft bearing manufacturer's serial number 256, was manufactured by de Havilland Canada in July 1969, and was registered in the Maldives on 07 January 2010, under the registration 8Q-MBC. The initial Certificate of Registration (number CR-225) was issued to Maldivian Air Taxi

and this certificate was later revised on 05 April 2012 upon merger of Maldivian Air Taxi and TMA. The Certificate was reissued to Trans Maldivian Airways on 15 August 2013. Since then, the aircraft has been operated by TMA.

1.1.3 Flight crew

The aircraft was operated by two flight crew members and a cabin crew. All had valid licenses issued by MCAA. Crew license details including flight hours are detailed in section 1.5 of this report.

1.2 Injury to persons

Injuries	Flight Crew	Cabin Crew	Passengers	Total on board	Others
Fatal	0	0	0	0	0
Serious	0	0	0	0	0
Minor	0	0	0	0	0
Nil	2	1	15	18	0
Total	2	1	15	18	0

1.3 Damages to aircraft

The wing and the right hand propeller sustained minor damages, as detailed below:

1. Left Wing leading edge dented in three places
2. Right Wing tip fairing damaged
3. Right propeller – One blade damaged

1.4 Other Damage

As a result of the aircraft coming in contact with the wooden structure the staircases of two water bungalows were found damaged. These include dislocation of several deck planks.

1.5 Personnel information

1.5.1 Pilot-In-Command

Age:	44 years
Nationality:	Maldives
Gender:	Male
Type of License:	ATPL-A
License issued on:	01.03.2018
License expires on:	23.03.2023
Type of medical:	Class 1
Medical issued on:	10.07.2021
Medical expires on:	10.07.2022
Types flown:	DHC-6 series
Hours on type:	14,706.5 hours
Ratings:	DHC-6/IR
Last Proficiency check:	19.03.2021
Total hours as PIC:	12,500:4 hours
Total flight time:	15,006:5 hours
Last 90 days:	263:28 hours
Last 28 days:	98:8 hours
Last 24 hours:	6:5 hours
Last rest period:	10, 11 and 12 November 2021

1.5.2 Co-pilot

Age:	34 years
Nationality:	Maldives
Gender:	Male
Type of License:	CPL-A
License issued on:	07.12.2017
License expires on:	17.01.2023
Type of medical:	Class 1
Medical issued on:	10.08.2021
Medical expires on:	10.08.2022
Types flown:	DHC-6 series
Hours on type:	4851:01 hours
Ratings:	DHC-6

Last Proficiency check:	19.03.2021
Total flight time:	5148:81 hours
Last 90 days:	191:91 hours
Last 28 days:	87:31 hours
Last 24 hours:	12:6 hours
Last rest period:	8, 9 and 10 November 2021

1.5.3 Cabin Crew

Age:	34 years
Nationality:	Maldivian
Gender:	Male
Type of License:	CCL
License issued on:	13.11.2018
License expires on:	12.11.2023
Type of medical:	Class 3
Medical issued on:	15.09.2020
Medical expires on:	14.09.2022
Last rest period:	7, 8 and 9 November 2021

1.6 Aircraft Information

1.6.1 General information

The DHC-6-300 "Twin Otter" is an unpressurised, all-metal, high wing aircraft powered by two Pratt & Whitney PT6A-27 engines driving four-bladed, reversible-pitch, full feathering propellers manufactured by MT Propeller – a company incorporated in Germany. The aircraft is designed for seating two pilots, side by side with dual controls, standard and optional flight instrumentation.

Manufacturer:	de Havilland Canada
Registration:	8Q-MBC
Powerplants:	PT6A-27
Manufacturer's Serial Number (MSN):	256
Year of construction:	1969
Total Air Time and Landings at time of incident:	51,892:72 hrs. and 91,358 landings
Certificate of Airworthiness:	Normal category, issued on 20 Jan 2010

Airworthiness Review Certificate:	Issued date: 20 Jan 2019
Last periodic inspection	EMMA No 28 on 26 October 2021
Last inspection carried out at TAT / CYC	51,803:97 hours / 91,156 cycles

Last daily inspection was carried out at 21:00 hrs on 12 Nov 2021, and the last engine wash was recorded as carried out on 13 Nov 2021 – the day of occurrence.

1.6.2 Engines and Propellers

The aircraft was installed with 02 PWC PT6A-27 turbo prop engines, driving four-bladed, reversible-pitch, full feathering propellers manufactured by MT Propeller, Germany. This type of MT propeller is installed under an approved STC accepted by the MCAA.

Right Engine (Gas Generator)	
Right engine manufacturer	PWC
Year of manufacture	Unknown
Model	PT6A-27
Serial number	PCE-51552
Total Hours since new	17,720:09
Last overhaul date	17 February 2000
Hours since overhaul	4,430:69
Right Engine (Power Section)	
Right engine manufacturer	PWC
Year of manufacture	Unknown
Model	PT6A-27
Serial number	51552-100
Last overhaul date	17 February 2000
Hours since overhaul:	4,430:69
Last check carried out:	EMMA No 28 on 26 October 2021
Hours since last check:	88:75 hours
Left Engine (Gas Generator)	
Left engine manufacturer:	PWC

Year of manufacture:	Unknown
Model:	PT6A-27
Serial number:	PCE-41747
Total Hours since new:	26,487:10
Last overhaul date:	10 October 2014
Hours since overhaul:	2,427:28
Last check carried out:	EMMA No 28 on 26 October 2021
Hours since last check:	88:75 hours
Left Engine (Power Section)	
Right engine manufacturer:	PWC
Year of manufacture:	Unknown
Model:	PT6A-27
Serial number:	40904-100
Last overhaul date:	10 October 2014
Hours since overhaul:	2,427:28
Last check carried out:	EMMA No 28 on 26 October 2021
Hours since last check:	88:75 hours
Right Hand Propeller	
Manufacturer:	MT Propeller
Year of manufacture:	2021
Model:	MTV-16-1ECFR(P)
Serial number:	200446
Last overhaul date:	N/A
Hours since last overhaul:	N/A
Last check carried out:	EMMA No 28 on 26 October 2021
Left Hand Propeller	
Manufacturer:	MT Propeller
Year of manufacture:	2021
Model:	MTV-16-1ECFR(P)
Serial number:	200445

Last overhaul date:	N/A
Hours since last overhaul:	N/A
Last check carried out:	EMMA No 28 on 26 October 2021

1.6.3 Cabin Layout and Configuration

Cabin was reconfigured under a LOPA approved by an EASA approved Design Organization to carry fifteen passengers and one cabin crew in a standard floatplane configuration. In this configuration the seat in the sixth-row position is removed for carriage of passenger luggage in the cabin rather than carrying them in the dedicated cargo compartments, the reason being that the forward cargo compartment is not accessible for loading the luggage while the aft cargo compartment is not large enough to accommodate all the luggage normally carried by fifteen passengers. The aft baggage compartment is only used for loading smaller luggage.

The aircraft was in float configuration with Wipaire 13000 floats installed and has four exits in the cabin and two in the cockpit. In this configuration the right aft door is approved to be blocked.

1.6.4 Recent maintenance

The most recent maintenance inspections carried out include Equalized Maintenance for Maximum Availability (EMMA) check number 28 complied with on 26 October 2021, at 51,803.97 TAT and 91,156 TAC.

1.6.5 Flight Controls

The flight controls consist of conventional, manually actuated primary flight controls operated through cables, pulleys, and mechanical linkages. Rudder and elevator trim are manually controlled and mechanically actuated; aileron trim is electrically actuated. Secondary flight controls consist of hydraulically actuated wing flaps.

No abnormalities were reported on any of the flight controls or related systems.

1.6.6 Fuel

Jet A-1 fuel was used on the aircraft engines and the last refueling was carried out in ReethiFaru water aerodrome.

1.6.7 Accessories

Aircraft was fitted with Garmin G950 suite. The associated data cards were recovered without damage and was available for the investigation.

1.6.8 Defects

The aircraft had no recorded open defects.

1.6.9 Aircraft loading

The aircraft departed ReethiFaru water aerodrome with a take-off mass of 10,438 lbs. The landing mass recorded at arrival in Finolhu Resort water aerodrome was 10,288 lbs.

Mass breakdown at departure from Finolhu

Passengers in transit:	1 Male, 3 Female
Mass of transit passengers:	639 lbs
Mass of all 7 pieces of transit luggage:	195 lbs
Passengers joining at Finolhu Resort:	4 Male, 5 Female, 1 Child, 1 Infant
Mass of joining passengers:	1,583 lbs
Mass of 13 piece of joining luggage:	431 lbs
Co-Mail:	5 lbs
Actual T/O weight:	12,277 lbs
Max T/O weight limit as per AFM	12,500 lbs

Calculated take-off weight reflected in the loadsheet is 223 lbs below the maximum Take-Off weight.

1.7 Meteorological information

There were no recorded weather data available at the Finolhu water aerodrome, and the nearest recorded data was available from Dharavandhoo automatic weather station, which is approximately 25km north-east of Finolhu water aerodrome. Winds recorded at Dharavandhoo at 17:10 hrs on 13 November was 24.5 mph (gusting 30.6 mph) from WSW direction.

A yellow weather alert for strong winds of 25-30 mph, with gusts up to 40 mph and rough seas, over Baa Atoll region was active from 16:00 to 19:00 hrs on 13 November 2021.

1.8 Aids to Navigation

The aircraft was operating under VFR.

1.9 Communications

There were no communication problems or system anomalies throughout the flight from taxi to aborted take-off and during the towing back to platform.

1.10 Aerodrome information

Departure Aerodrome: Finolhu Resort water aerodrome

Reference Floating – N 05° 0' 48.18', E 72°57' 20.22'

Attached – N 05° 0' 44.84', E 72° 57' 11.71"

Facilities: 1 fixed platform, 1 floating platform and 1 mooring buoy

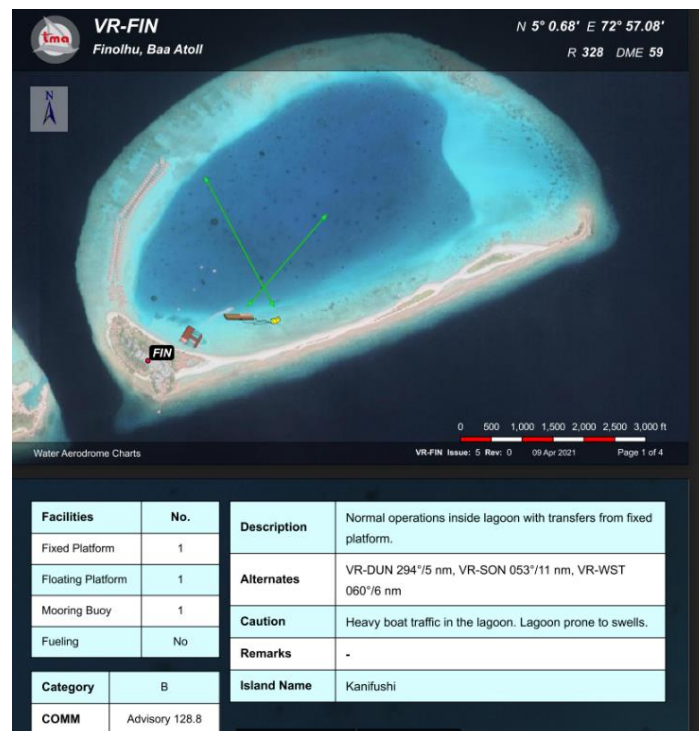

Fig. 1: Finolhu Resort Water Aerodrome Chart

Aerodrome License for Finolhu Resort (Kanifushi Island), bearing license number AP/O/92, was issued to Trans Maldivian Airways Pvt Ltd., on 28 November 2010.

1.11 Flight Recorders

No flight data recorder (FDR) or Cockpit Voice Recorder (CVR) was installed on the aircraft, and they are not required under MCARs.

However, Garmin G950 suite installed records data in the SD cards forming part of the cockpit display (MFD). The data saved in the data card was reviewed during the investigations.

1.12 Wreckage and impact information

1.12.1 Incident site visit

Incident site was visited by investigators from both AICC and MCAA. During this visit the aircraft was visually checked for damages. The damages sustained on the water bungalows were also recorded. The aircraft systems functional checks were carried out with LH engine running. RH engine could not be run because of damages sustained on the propeller fitted.

1.12.2 Wreckage Condition

For details of the damages sustained reference may be made to section 1.3 of this report.

1.12.3 Salvage operations

No salvage operation was required, but a powered dinghy was used to tow the aircraft to the floating platform, post incident.

1.13 Medical and pathological information

Both flight crew members and the cabin crew were subjected to drug tests. The results of the tests carried out were reported negative for all three crew members.

1.14 Fire

There was no fire or fire alarms.

1.15 Survival Aspect

There was no search and rescue involved in this incident. Shortly after the incident, while the passengers and crew were on board, the aircraft was towed back to the platform by a powered dinghy. Life jackets were available on board but none was used.

1.16 Tests and research

During the investigation of the incident both power and propeller levers were checked for full and free movement and all levers were found to be functioning satisfactorily. LH engine run was carried out to check if any difficulty was present in applying reverse and it was found to be functioning normal, confirming that the defective condition reported by the flight crew was not present at the time of carrying out the checks. Since the RH propeller was damaged, the RH engine was not run.

1.17 Organizational and Management Information

TMA is a MCAA approved Air Operator Certificate holder. TMA provides domestic air services with a fleet of over 50 DHC-6 aircraft on floats. The company is authorized to conduct day VFR operations.

The company holds Aircraft Maintenance Organization Approval reference MV.145.025 issued by the MCAA.

1.18 Additional Information

None

1.19 Useful or Effective Investigation Techniques

The recorded data on G950 suite was used to analyze the engine and flight parameters relating to the incident flight. Recorded video footages from CCTV cameras of the resort, and one of the occupants residing in one of the water bungalows were also used for carrying out the analysis.

2.0 ANALYSIS

2.1 General

The aircraft attempted to take-off in a North Westerly direction towards a stretch of water bungalows. During the take-off run the aircraft was momentarily airborne and the aircraft settled back on water, the PIC decided to abort the take-off.

The crew then attempted to apply engine reverse power to stop the aircraft forward movement, but despite repeated attempts, they were unable to select engine reverse power and hence engaged the fuel shut-off valves to shut down both the engines. In spite of shutting down the engines, the aircraft moved on its own momentum and came in contact with two water bungalows.

This analysis focuses on the operational, technical and infrastructure issues that may have contributed to this serious incident.

2.2 Crew Qualification and Training

2.2.1 Pilot-in-Command (PIC)

The PIC was the PF on this sector departing Finolhu water aerodrome, and was seated on the RH seat in the cockpit. He has 18 years of experience flying DHC-6 (Twin Otter) floatplane. On the incident flight he was conducting line indoctrination training for the FO (pilot-in-command under supervision). When enquired from the PIC, if operating out of RH seat causes any difficulty, the PIC stated that he is used to flying from either LH or RH seats and therefore no difficulties were experienced. The PIC stated that he did not experience any signs of fatigue, either.

2.2.2 First Officer (FO)

The FO was flying under supervision from the left-hand seat and was PM. He had nearly completed the required 100 hrs flying in PICUS, but had yet to complete the number of sectors required. On this sector, the FO was in charge of computing the weight and balance calculations and completing all other documentation required.

2.3 Crew Duty Time / Sector Limitations

Both crew members reported to duty at 05:30 hrs at TMA base. The PIC reported to duty after a three-day rest period. The FO was on the third day of his duty, after a three-day rest period.

Therefore, crew duty time was not a contributing factor.

2.4 Weight & Balance

During the investigation the quantity of fuel on both tanks were determined from the fuel gauges. LH gauge (FWD tank) indicated 411 lbs while RH gauge (AFT tank) indicated 427 lbs, totaling a fuel weight of 838 lbs.

The calculated weight of fuel, as computed by the flight crew prior to departure was found to be 670 lbs. (TMAPP WB Report ID 622597- dated Saturday 13 Nov 2021, 17:05:26 – FIN to MLE). An entry in the Aircraft Technical Logbook (Log number 143903, route entry, row number 12) stated that 670 lbs of fuel was available at departure.

The fuel mass used in the calculations was 168 lbs less than the total fuel mass indicated on both the fuel gauges. There existed a discrepancy. This could be the result of varying attitudes and configuration of the aircraft after loading and unloading. Even if inconsistencies in the fuel mass recordings existed between the recorded and that of the indications observed during investigation, the maximum mass of the aircraft would not exceed the MTOW, as prescribed in the AFM and it cannot be construed as a contributing factor.

It was observed that in the Operator's main base at VIA, for all departing flights, the hand luggage mass is recorded separately, but at all other water aerodromes, the mass of the hand luggage is not recorded separately. Mass of the luggage and hand luggage are combined and used in the weight and balance calculations. The Resort Agent at RFR confirmed that the mass of hand luggage was included in the recorded luggage mass used in the calculations.

An electronic Mass and Balance Report produced by the Flight crew before departure was available on the PED provided by the Operator for use by flight crew members. According to this report, Take-off Weight, the CG for take-off from Finolhu water aerodrome and estimated landing weight at

destination remained within the prescribed limitations. These are therefore ruled out as contributing factors.

2.5 Take off path

The PIC who was the PF, stated that the weather was below favorable conditions at the time of the incident. He noted that on the incident flight the most favorable take-off path would have been a westerly direction as the wind was from WSW. However, in order to avoid taking-off towards the island or between the island and the water villas (over the walkway between the island and the water villas) the PIC chose a north westerly direction towards the water bungalows (having an approximate height of 7.2 meters above mean sea level). The PIC confirmed that once airborne, he was hoping to level off and turn right slightly and climb out to avoid flying over the water bungalows.

For the selected take-off path, the distance from the point where the take-off was seen to initiated up to the water villa with which the aircraft contacted was approximately 2260 ft (refer to Fig 2).

The Crew had the option of selecting other paths for take-off. Had the crew moved further out (north-east) before lining up for take-off, where adequate take-off distance was available, ensuring clearance from the water bungalows. Thus, the decision taken by the PIC to initiate the take-off run from where he did, instead of taxiing out further north-east, is construed as a contributing factor.

The G950 data suggests the aircraft lifted off within 23 seconds into the take-off run and the aircraft appeared to be off the water for about 3 seconds covering a distance of about 164 feet. When the aircraft settled back on water, the aircraft was approximately 750 feet from the water villas.

The PIC recalls that as soon as the aircraft was airborne, an unfavorable gust of wind caused the aircraft to settle back on water. The G950 data also indicated that, at around the same time, engine power on both engines was reduced to idle thus indicating the take-off was aborted at that point.

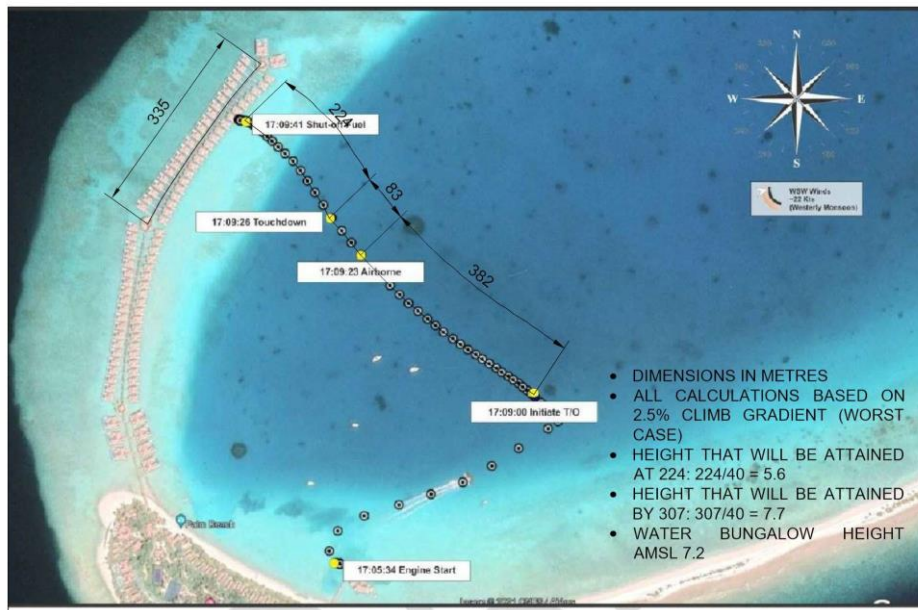

Fig. 2: 8Q-MBC – Flightpath recreated using data from Garmin G950 Aonics suite provided by the operator

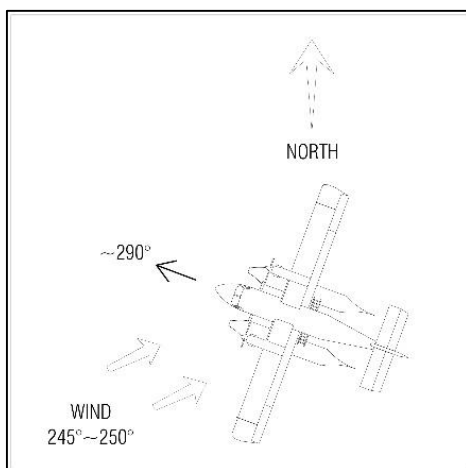

Fig 3: Aircraft T/O direction

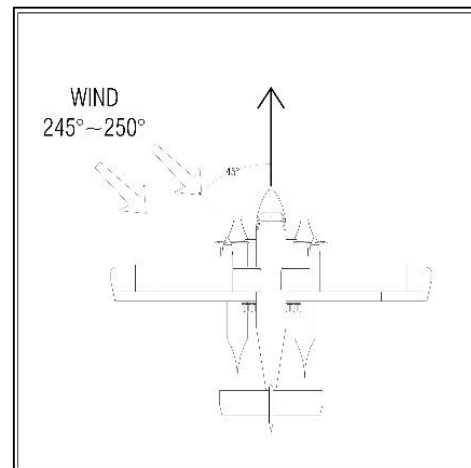



Fig 4 : Aircraft vs. cross wind direction

The maximum demonstrated cross wind component as per the Operator’s OM-Part B clause 1.10.1 “Crosswind and headwind component” (Volume 1 DHC-6 Floatplane operations) is 17 knots measured at 6 feet. This is not a limitation but a demonstrated crosswind – published by the manufacturer.

1.10 WIND LIMITATIONS

CONDITIONS	WIND SPEED	REMARKS
HEADWIND	20 kts	NOT LIMITING. However for operations in winds greater than 20 Kts, the take-off and landing data appropriate to 20 KIAS should be used.
TAILWIND	10 kts	LIMITING. Take-off and Landing with tailwinds greater than 10 Kts is prohibited.
CROSSWIND (DeHavilland AFM)	27 kts	NOT LIMITING. This is the maximum demonstrated crosswind component published in the AFM. Conditions for demonstration were 20 Kts of wind measured at 6 feet, which is equivalent to 27 Kts at a tower height of 50 ft.
CROSSWIND (Wipline AFM Sup)	17 kts	NOT LIMITING. This was the maximum demonstrated crosswind component during flight tests. Conditions are not mentioned.

Fig 5: Wind Limitations for DHC-6 300 series aircraft



DHC-6 SERIES 300

TC Approved

SECTION 4
NORMAL PROCEDURES

3 Power levers – Advance smoothly to the full calculated take-off power setting (Figure 5-7). Check that the autofeather ARM light illuminates.

If a maximum performance take-off is desired, do not release the brakes until full take-off power has been set. It is not mandatory to set full calculated take-off power prior to brake release if sufficient runway and clearway is available to allow for a gradual increase in power from 85% N_G to full calculated take-off power following brake release. As airspeed increases, torque pressure will increase with a constant power lever setting. Adjust the power levers as required to avoid exceeding the calculated take-off power setting.

4 Maintain directional control with rudder.

5 Rotation IAS – As indicated in figure below.

ROTATION SPEEDS ($V_R = V_1$)

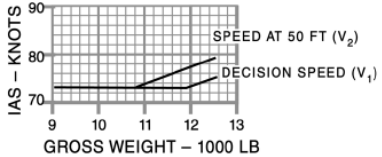

Figure 4-1 Rotation Speeds SFAR 23

6 Speed at 50 feet – 80 KIAS (all weights), or, according to Figure 4-1 if maximum performance is required.

7 Climb to a minimum of 400 feet AGL at 80 KIAS (all weights) prior to retracting flaps.

8 Do not reduce power from the take-off power setting until flap retraction is complete.

4.10.1 Crosswind Take-Offs

Take-off has been performed in crosswind components of up to 20 knots measured at 6 feet, which is equivalent to 27 knots at a tower height of 50 feet. This is the maximum experienced during crosswind trials and is not considered a limitation. Some application of "into wind" aileron will assist in maintaining wings level during the ground roll.

Revision: 53
Date 10 Sep. 2010

PSM 1-63-1A
Page 4-37

Fig 6: TC Approved POH & AFM 1-63-1A Section 4.10.1 – Cross Wind Take-Offs for DHC-6 300 series aircraft

2.6 Inability to Reverse

According to both the crew members, while rejecting the take-off, the PIC moved the power levers to ground idle, but was unable to move the power levers to the reverse position. The PIC stated that three attempts were made to move the power lever aft of the gate position, while verbally calling out his actions. The FO suggested to shut off the fuel but the PIC decided and advised the FO to try and engage the reverse as the situation could be brought under control once the reverse power is applied. Hence a fourth unsuccessful attempt was made to engage reverse power. The PIC finally permitted the FO to shut off the fuel and subsequently propeller blades were feathered.

Immediately after the propeller blades were feathered, the aircraft veered further towards left and continued to move forward, under momentum, until the aircraft came in contact with the water villas in front.

Failure to move the power levers aft of the gate position could be attributed to the following two main reasons:

1. The position of both propeller levers not at full forward (fully fine) position would mechanically lock the power levers at the flight idle position (also known as gate position); hence the power levers cannot be moved aft of the idle position. (TMA Operations Manual Part B – Vol I float Operation Issue 2 Rev 4 dated 11 Jul 2017, under 2.7.7.3 – Landing Procedures – under clause 15, a caution states that the reverse power cannot be applied unless BOTH the propeller levers are at full forward position) The power lever linkage is designed to mechanically lock the power lever being pulled aft of the flight idle position whenever any one of the propeller levers is not fully forward.
2. If the crew operating the power lever fails to twist the power lever grips to overcome the mechanical stop while attempting to reverse, the power levers will not move beyond the mechanical stop.

During the investigation, both the power levers and propeller levers were checked for full and free movement and both power levers and both the propeller levers were found to be functioning satisfactorily with no mechanical failures or restrictions. . The LH engine was run and when reverse was selected, the engine responded accordingly. The RH engine was not run

due to damages on the propeller blade. The operation ruled out any mechanical malfunction of the power levers.

At the time of rejecting the take-off, the Np of both the propellers were below the maximum which indicated that the propeller levers were not fully forward. The propeller levers may have moved back due to aircraft bumping on waves during the take-off run in the rough weather. Experience of the operator has shown that the propeller levers move back during bumpy take-off runs. In this occurrence, it would appear that the propeller levers have moved back from the fully forward position as indicated by the propeller Np values.

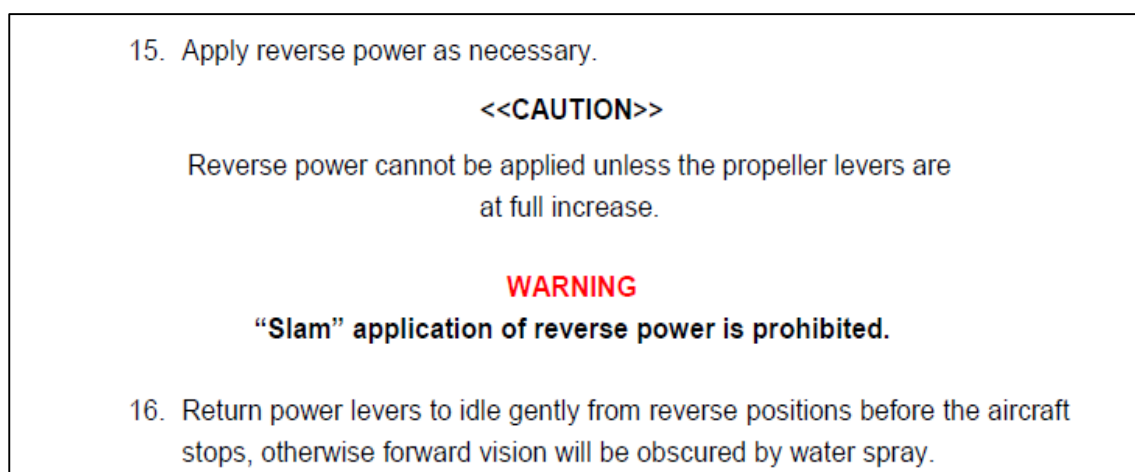

Fig. 7: TMA Operations Manual Part B – Vol I float Operation Issue 2 Rev 4 dated 11 Jul 2017
Section 2.7.7.3 – Landing Procedures – clause 15

2.7 Engine Power

The crew noted that during take-off LH engine torque pressure was indicating 46 'psi', whereas the RH engine torque pressure was indicating '49/50 'psi.

According to the PIC, during the monsoon weather when high swells and strong winds are present, engine performance gets affected due to salt ingress into the engines, and this effect is more obvious in flights in the late afternoon, towards the end of the day. In such situations, at times, the available torque drops below the required minimum. On the day of the incident the highest recorded torque on G950 for each take-off, for both engines are tabulated below.

	<u>Highest recorded</u>	<u>Highest recorded</u>
	<u>Torque - LH</u>	<u>Torque - RH</u>
Flight 1	37.74 ft lbs	37.61 ft lbs
Flight 2	37.35 ft lbs	37.44 ft lbs
Flight 3	37.24 ft lbs	37.32 ft lbs
Flight 4	36.86 ft lbs	37.47 ft lbs
Flight 5	36.38 ft lbs	36.88 ft lbs
Flight 6	36.11 ft lbs	37.27 ft lbs
Flight 7	35.99 ft lbs	37.05 ft lbs
Flight 8	35.47 ft lbs	36.55 ft lbs
Flight 9	34.85 ft lbs	36.41 ft lbs
Flight 10	35.47 ft lbs	36.67 ft lbs
Flight 11	35.47 ft lbs	37.63 ft lbs
Flight 12	34.61 ft lbs	37.89 ft lbs

Note: The G950 suite records Torque values in foot lbs while the Torque indicator is calibrated in psi. It can be seen from the above data that the LH engine torque had decreased by 8.2%.

The engine torque requirement for takeoff, according to the Operator's OM-Part B (Volume 1 DHC Floatplane operations) is 50 psi. Throughout the day, the torque recorded on the G950 was between 34 to 37 foot lbs (not psi) and the torque recorded on the incident flight also falls within the same torque range. On the day of the incident all the flights that were successfully completed, indicated the same torque values with no issues recorded or otherwise communicated.

1.14.2 Engine Limitations – Manufacturer

1.14.2.1 PT6A-27 Engine on DHC-6 300 Series

POWER SETTING	MANUFACTURER OPERATING LIMITATIONS – PT6A-27						
	SHP	TORQUE PSI (1)	T5 °C	Ng % (2)	Np % (9)	OIL PRESS psi (3)	OIL TEMP °C (4)
TAKE-OFF & MAX CONT.	620 ISA + 18°C	50	725	101.6	96	80 to 100	10 to 99
MAX CLIMB / CRUISE	620 ISA +6°C	50	695	-	96	80 to 100	0 to 99
IDLE	-	-	660 (5)	-	-	40 min. (3)	-40 to 99
STARTING (8)	-	-	1090 (6)	-	-	-	-40 min
ACCELERATION	-	68.7(6)	825 (6)	102.6	110	-	0 to 99
MAX REVERSE (7, 10)	620	50 (7)	725	101.5	91±1	80 to 100	0 to 99

Fig 8: PT6A-27 Engine Limitations for DHC-6 300 series aircraft

2.8 Hurry Up syndrome

Hurry-Up Syndrome is defined as any situation where a pilot's human performance is degraded by a perceived or actual need to hurry or rush tasks or duties for any reason. These time-related pressures include the crew desire to meet a restriction in clearance time, the pressure to keep on schedule when delays have occurred due to weather, or the inclination to hurry to avoid exceeding duty time regulations, and many other situations.

It was noted that the crew had strong concerns relating to completing last scheduled flight of the day from MLE to Rangali island before the twilight ends. Crew were also aware of the unfavorable weather situation and its potential to delay the impending take-off and the possibility that they may not make it to the final destination for the night before twilight ends. Considering nearing completion of a very long day, it can be deduced that crew performance would have tended to wane.

Sunrise/Sunset tables in the Aeronautical Information Publication (AIP) published by the Maldives Airports Company Limited (MACL), include sunrise and sunset timings for most of the land aerodromes. Dharavandhoo Airport

is the nearest aerodrome to the incident location, for which sunrise / sunset data is made available.

The twilight end time at Conrad Maldives water aerodrome is used from the sunrise and sunset data published for Villa Airport Maamigili, which is the nearest location to the Conrad Maldives water aerodrome. Hence, on the day of the incident the twilight end time at Conrad Maldives water aerodrome was 18:12 hrs.

Based on the above twilight end time the crew would have 61 minutes from the time of the incident, which occurred at 17:11 hrs, to complete the last flight before twilight ends.

The shortest possible flight distance (straight line) from FIN to MLE is 60.48 nm and the distance from MLE to Conrad Maldives water aerodrome is 59.83 nm. To cover both flights approximately 61 mins of flying time is required based on average cruising speed of 120 knots. This does not include any air traffic delays and the turnaround time at MLE.

Considering the circumstances, the crew appear to be under pressure to return to main base and complete the last flight of the day to Conrad Maldives water aerodrome at Rangali island, Alif Dhaalu atoll. There was very limited time left to complete both the flights before the twilight ends in Rangali island, and therefore it is highly likely that the 'Hurry-up syndrome' would have contributed to this incident.

3.0 CONCLUSIONS

3.1 Findings

- a. Both the crew members were found to possess the required qualifications to perform the intended flight and no crew qualification issues were noted;
- b. Based on the Weight and Balance Report, the weight of the aircraft and the weight distribution were found to be within the prescribed limitations;
- c. The take-off path was in a north westerly direction towards the water bungalows;
- d. The take-off was aborted when the crew realised that the water bungalows in front were too close;
- e. The crew were unable to select reverse, and subsequently both engines were shut down;
- f. The aircraft came in contact with the water bungalows shortly after both the engines were shut down;
- g. The examination of the engine control levers did not reveal any abnormality of the engine control mechanisms;
- h. The crew was scheduled to fly another final sector on returning to base, after this incident flight, before the twilight ends.

3.2 Causes / Contributing Factors

The AICC determines that the causes / contributing factors of this incident were:

- a. The take-off direction was inappropriate as the take-off line passes over the water bungalows;
- b. The crew were unable to apply reverse power after rejecting the take-off;
- c. The crew were unable to shutdown the engines in a timely manner;

- d. The crew were unable to turn the aircraft away from the bungalows;

3.3 Recommendation to all Operators

To identify and document appropriate take-off lines in all water aerodromes.

3.4 Recommendation to the Regulator

To re-examine the criteria for carriage of recorders on transport category aircraft certified to carry more than 9 passengers.

4.0 APPENDICES

4.1 Flight release documents

a. Operational Flight Plan

OPERATIONAL FLIGHT PLAN - DAY / VFR					TMA FLIGHT RELEASE			A/C Type	Printed by	rebeu ahmed
13-Nov-21	14:35	FLT772157	8Q-MBC	8769	11.3	12500	KTAS 135	DHC-8-300	Printed Time	13-Nov-21 14:37:00
								Flight Level	Phone No.	
SECTOR	MLE-MMG	MMG-RFR	RFR-FIN	FIN-MLE						
SMED	1445	1530	1559	1629						
ETE	38	6	16	29						
MAG BRG	337	012	182	149						
DIST (nm)	60	7	26	60						
OFF BLOCK	1616	1612	1624							
TAKE OFF	1522	1614	1638							
LAND	1605	1630	1654							
ON BLOCK	1608	1624	1657							
AIR TIME	47	06	16							
BLOCK TIME	52	12	23							
BOARDING	14(0)+0	0(0)+0	4(0)+0	**3(0)+1						
TOT ON BOARD	14(0)+0	10(0)+0	4(0)+0	14(0)+1						
DISSEMBARKING	4(0)+0	10(0)+0	0(0)+0	14(0)+1						
A/C APS	8769	8769	8769	8769						
PAX	2 076	1 583	839	2 222						
BAGGAGE	709	583	192	1434						
MAN AJUST	0	0	0	0						
W FUEL	-390	0	390	0						
FUEL @ T/O	946	836	826	656						
T/O MASS	12,499	11,470	10,455	12,404						
MAN AJUST	0	0	0	0						
SECTOR BURN	380	60	150	290						
LDG MASS	12,119	11,410	10,305	12,114						
OPS FUEL O/B	470	440	410	380						
MIN FUEL REQ	1358	843	850	670						
W FUEL	-390	0	390	0						
FUEL @ DEP	962	850	850	670						
SECTOR BURN	380	60	150	290						
TAXI FUEL	30	30	30	30						
FUEL @ ARR	550	480	670	560						
TOTAL BURN	410	500	680	1000						
C of G % MAC	30	17								

Sunset/Grounding	
13.11.2021	14.11.2021
TWIL From	05:30 05:30
Sunrise	05:52 05:52
Sunset	17:48 17:48
Grounding	18:10 18:10
TWIL to	19:10 19:10

Tides			
13-11-2021		14-11-2021	
Time	Tide	Time	Tide
00:27	0.4	03:50	0.4
06:19	0.6	09:51	0.7
15:57	0.4	18:40	0.3
22:33	0.6	23:18	0.7

The report is made in accordance with CAT PCL MAS 100 for the

This flight release has been prepared in accordance with MCAR Air CU-reports and The Flight Operations Manual

Signature: _____

Flight Operations Signature: _____

CHECK REPETITIVE ITEMS

International Departure Passengers - Manifest							
Page Number	Note	Name	Hand type	Ck. In Logg	Description	Altport	Type
0		TOTAL COUNT	0	0			
9033170			1	2	RFR	MMG	FEMALE
9061048			1	1	RFR	RFR	MALE
9081645			1	1	RFR	RFR	FEMALE
9068762			1	1	RFR	RFR	FEMALE
4			4	5	RFR		
9067724			1	1	FVR	FIN	FEMALE
9067725			1	1	FVR	FIN	MALE
9067726			1	1	FVR	FIN	FEMALE
9067727			0	2	CRS	FIN	CHILD
9067728			0	1	FVR	FIN	INFANT
9069195			0	2	FVR	FIN	MALE
9071852			0	2	FVR	FIN	FEMALE
9071853			1	1	FVR	FIN	MALE
9071854			0	1	FVR	FIN	FEMALE
9075004			0	1	FVR	FIN	FEMALE
11		TOTAL COUNT	5	14			

Route: MMG - (MMG-R), RFR - (RFR-1/4), FIN - (FIN-0/1)

BUMPED / ADDITIONAL BAGGAGE / VEH RESORT (CHN) INFORMATION

DELAY / OUTSTATION DEFECT REPORT

NOTAMS See Reverse Side

b. Passenger List – Flight Release (Page 1 of 2)

Pax list - Flight Release: Departures from MLE Page 1
 Flight date: 13. November 2021 Flight Filters : No.: FLT772157 Printed Time 13-November-21 14:36:22
 Trans Maldivian Airways Pvt. Ltd. Printed By [REDACTED]

Captain [REDACTED] Released Time 2:35:31 PM First released Time 2:35:31 PM Check in Closed 2:03:27 PM
 First Officer [REDACTED] Released Date 13-11-21 First released Date 13-11-21
 Flight Attendant [REDACTED] Released By [REDACTED] First released By [REDACTED]
 Aircraft **MBC** Flight Colour: [REDACTED]
 Flight No. **FLT772157** Routing **MLE - MMG - RFR - FIN - MLE**

Arr. Airport	MMG	Departure	2:45:00 PM	Arrival	3:23:00 PM	Luggage		Hand lug.		Check In	Last	Note
Pax No.	Name	Reference	Type	Operator	VIP	Conn. Flt Code	Count	Weight	Count	Weight	Time	Checke
[REDACTED]	[REDACTED]	[REDACTED]	MALE	[REDACTED]	[REDACTED]	[REDACTED]	2	46.80	1	5.00	12:14:58	[REDACTED]
[REDACTED]	[REDACTED]	[REDACTED]	CHILD	[REDACTED]	[REDACTED]	[REDACTED]	2	46.80	1	5.00	12:15:09	[REDACTED]
[REDACTED]	[REDACTED]	[REDACTED]	CHILD	[REDACTED]	[REDACTED]	[REDACTED]	1	23.40	0	0.00	12:15:04	[REDACTED]
[REDACTED]	[REDACTED]	[REDACTED]	FEMAL	[REDACTED]	[REDACTED]	[REDACTED]	0	0.00	0	0.00	12:15:02	[REDACTED]
							5	117.00	2	10.00		
Pax #	4	Pax Weight	493.00			Luggage Count/Weight	7	127.00				

Arr. Airport	RFR	Departure	2:45:00 PM	Arrival	3:44:00 PM	Luggage		Hand lug.		Check In	Last	Note
Pax No.	Name	Reference	Type	Operator	VIP	Conn. Flt Code	Count	Weight	Count	Weight	Time	Checke
[REDACTED]	[REDACTED]	[REDACTED]	MALE	Reethi Faru	[REDACTED]	[REDACTED]	1	32.25	1	10.00	10:57:10	[REDACTED]
[REDACTED]	[REDACTED]	[REDACTED]	FEMAL	Reethi Faru	[REDACTED]	[REDACTED]	1	32.25	0	0.00	10:57:14	[REDACTED]
[REDACTED]	[REDACTED]	[REDACTED]	FEMAL	Reethi Faru	[REDACTED]	[REDACTED]	1	32.25	0	0.00	10:57:19	[REDACTED]
[REDACTED]	[REDACTED]	[REDACTED]	CHILD	Reethi Faru	[REDACTED]	[REDACTED]	1	32.25	0	0.00	10:57:17	[REDACTED]
[REDACTED]	[REDACTED]	[REDACTED]	MALE	Reethi Faru	[REDACTED]	[REDACTED]	1	28.50	1	8.00	1:33:51	[REDACTED]
[REDACTED]	[REDACTED]	[REDACTED]	FEMAL	Reethi Faru	[REDACTED]	[REDACTED]	1	28.50	0	0.00	1:34:15	[REDACTED]
[REDACTED]	[REDACTED]	[REDACTED]	MALE	Reethi Faru	[REDACTED]	[REDACTED]	2	67.50	1	7.00	1:52:06	[REDACTED]
[REDACTED]	[REDACTED]	[REDACTED]	FEMAL	Reethi Faru	[REDACTED]	[REDACTED]	2	67.50	0	0.00	1:52:11	[REDACTED]
[REDACTED]	[REDACTED]	[REDACTED]	MALE	Reethi Faru	[REDACTED]	[REDACTED]	1	27.00	1	15.00	12:04:49	LB
[REDACTED]	[REDACTED]	[REDACTED]	FEMAL	Reethi Faru	[REDACTED]	[REDACTED]	0	0.00	0	0.00	12:05:13	LB
							11	348.00	4	40.00		
Pax #	10	Pax Weight	1,583.00			Luggage Count/Weight	15	388.00				

Dep. Airport	Luggage		Hand lug.		Hand lug.+ Luggage		Passenger		Correction
	Count	Weight	Count	Weight	Count	Weight	Count	Weight	
MLE	16	465.00	6	50.00	22	515.00	14	2,076.00	2,591.00
MMG	11	348.00	4	40.00	15	388.00	10	1,583.00	1,971.00
RFR	0	0.00	0	0.00	0	0.00	0	0.00	0.00
FIN	0	0.00	0	0.00	0	0.00	0	0.00	0.00

c. Passenger & Cargo Manifest

11/13/21, 4:16 PM TRANS MALDIVIAN AIRWAYS

TRANS MALDIVIAN AIRWAYS
PASSENGER & CARGO MANIFEST

PRINT - Please print 2 copies for the captain

Date: Saturday, November 13, 2021 Checkin Close Time: 15:17:00
 A/C Reg.: MBC FL No.: FLT772157 Sequence of Close: 1 of 1
 Dep. Station: FINR Arr. Station: Resort Name: FINR
 Arr. Flight No.: Dep. Flight No.: Login ID:

Passengers:

Resort	Passenger No.	Name	VIP	Type	Conn. Flt.	Tour Opr.	Pcs.	Lug. Wgt.	Pax Wgt.	Checked In
FINR				FEMALE		FIN	1	42	150	✓
FINR				MALE		FIN	1	29	189	✓
FINR				MALE		FIN	1	56	189	✓
FINR				FEMALE		FIN	1	38	150	✓
FINR				CHILD		FIN	1	30	77	✓
FINR				INFANT		FIN	1	32	0	✓
FINR				MALE		FIN	2	81	189	✓
FINR				FEMALE		FIN	2	50	150	✓
FINR				MALE		FIN	1	26	189	✓
FINR				FEMALE		FIN	1	17	150	✓
FINR				FEMALE		FIN	1	30	150	✓

Weight of checked in pax only

Checked in Count	Lug. Weight	Pax Weight
11	431.00	1583.00

Cargo :

No.	Cargo	Tour Operator	Cgo. Wgt.
1	Co-Mail	Finothu	5.00

Total Cargo Weight
5.00

Last Minute Changes(manual input):

Name	VIP	Type	Conn. Flt.	Tour Opr.	Pcs.	Lug. Wgt.	Pax Wgt.

Aircraft weight (take-off, empty) _____

Captains Seat _____

Prepared by _____

8789
2019
10788
653
11443

Pax. Wgt	1583
Cgo Wgt.	5
Lug. Wgt.	431
TOTAL PAYLOAD	2019
APS WGT.	
Fuel	
T.O.W.	11443
Corr	834
ACT. T.O.W.	12277
Burn off	270
Landing WGT	11987

* All Weights in lbs.

Close Window

https://ts.transmaldivian.com/WebForms/Manifest.aspx?FlightNo=FLT772157&CurrentLeg=4&Resort_str=FIN 1/1

d. Mass and Balance Report



Mass & Balance Report

Saturday, 13 November 2021 - 8Q-MBC - 17:05:26 - FIN to MLE

Trip Information

AIRCRAFT	
Registration No	8Q-MBC
APS Index	11.28
APS Weight	8,768.58 lbs
CREW	
Pilot-in-Command	
ROUTE	
Departure	FIN Finolhu
Arrival	MLE Velana International Airport
Distance	60 nm
Bearing	145° SE
TOTALS	
Total Pax Weight	2,222.00 lbs
Total Fuel	850.00 lbs
Total Baggage	631.00 lbs
Take-Off Weight	12,456.58 lbs
Sector Burn	290.00 lbs
Landing Weight	12,166.58 lbs

Details

FUEL TANKS	
FWD Tank	425.00 lbs
AFT Tank	425.00 lbs
MOMENTS	
APS Moment	1,854,201.80
Take Off Moment	2,639,628.49
Landing Moment	2,581,483.49
SECTIONS	
Section A	489.00 lbs
Section B	978.00 lbs
Section C	755.00 lbs
Section D	311.00 lbs
Section Tail	0.00 lbs



Take Off CG

30% MAC



Landing CG

31% MAC

TMAPP WB Report ID: 622587, Generated on: 17-Nov-2021 14:48:12

4.2 Aircraft Technical Log

Aircraft Technical Logbook
Log No. 143903

Trans Maldivian Airways, Pvt. Ltd.
PO 2022, Velina International Airport, Republic of Maldives

DATE: 13/11/23 REG: 8Q-MBC TYPE: DUC-A-900

Route	Times		LOG	Eng Cycles		FUEL (kg)		AC	Crew Details Pilot / FO / CA	ENGINE TREND MONITOR		RIGHT
	Off Block	On Block		Alt Time	Stick Time	L	R			Used	Remaining	
UNM	0606	0609	0658	0658	46	52	500	990	1330	500	1330	45
MLE	0715	0718	0803	0806	45	51	540	-	870	ITT	613	36
SAP	0938	0942	1005	1007	23	29	300	570	920	NB	954	617
MNY	1010	1012	1017	1020	5	10	690	-	690	FF	320	948
MIR	1031	1034	1158	1104	24	33	600	-	600	Oil Temp	34	321
MBO	1144	1157	1230	1233	38	49	880	685	938	Oil PSI	89	92
VLE	1245	1247	1306	1308	19	23	555	495	655	Autofather System Ops Check		
VRL	1316	1319	1324	1327	05	11	830	-	830	Next Due: 16/11/2023		
MLE	1355	1358	1424	1440	36	45	760	-	760	Next Due: 16/11/2023		
MPL	1516	1528	1605	1608	47	52	610	610	960	Next Due: 16/11/2023		
RPL	1612	1614	1620	1624	06	12	550	350	550	Next Due: 16/11/2023		
FIN	1624	1638	1654	1657	16	23	460	390	850	Next Due: 16/11/2023		
MME							670	-	670	Next Due: 16/11/2023		

THIS LOG HOURS - LANDINGS & ENG CYCLES

PREVIOUS LOG: 51892.72 Hours: 91358 Landings: []

TOTAL: [] Hours: [] Landings: []

Oil	Oil Filter	Oil Cooler	Oil Drain	Oil Filter	Oil Cooler	Oil Drain	Oil Filter	Oil Cooler	Oil Drain
ON	ON	ON	ON	ON	ON	ON	ON	ON	ON
OFF	OFF	OFF	OFF	OFF	OFF	OFF	OFF	OFF	OFF
Oil Temp	Oil PSI	Oil Temp	Oil PSI	Oil Temp	Oil PSI	Oil Temp	Oil PSI	Oil Temp	Oil PSI
320	89	321	89	320	89	321	89	320	89

Engine Oil Check: [] Engine Oil Change: [] Engine Oil Filter: []

Top & Start: [] Drain & Time: []

Parts Used: [] Pits Used: [] EMMA # 229 TAT 5728.77

Engine Oil Check: [] Engine Oil Change: [] Engine Oil Filter: []

Top & Start: [] Drain & Time: []

Action Taken: [] Action Taken: [] Action Taken: []

THIS LOG HOURS - LANDINGS & ENG CYCLES

PREVIOUS LOG: 51892.72 Hours: 91358 Landings: []

TOTAL: [] Hours: [] Landings: []

Did not get reverse in both engines for the rejected takeoff

WHITE COPY - CAMO PINK COPY - DISPATCH GREEN COPY - STAYS IN LOGBOOK DUTY ENGINEER CONTACT # 719-1501 MAINTENANCE CONTROL CENTER CONTACT # 778-3072

*Certifies that the work specified, except as otherwise specified, was carried out I.A.W the MCAIR 145 and in respect to that work the aircraft/aircraft component is considered ready for release to service MV 145.025.

4.3 Engine data from G950

a. (Np, Fuel flow, G Force)

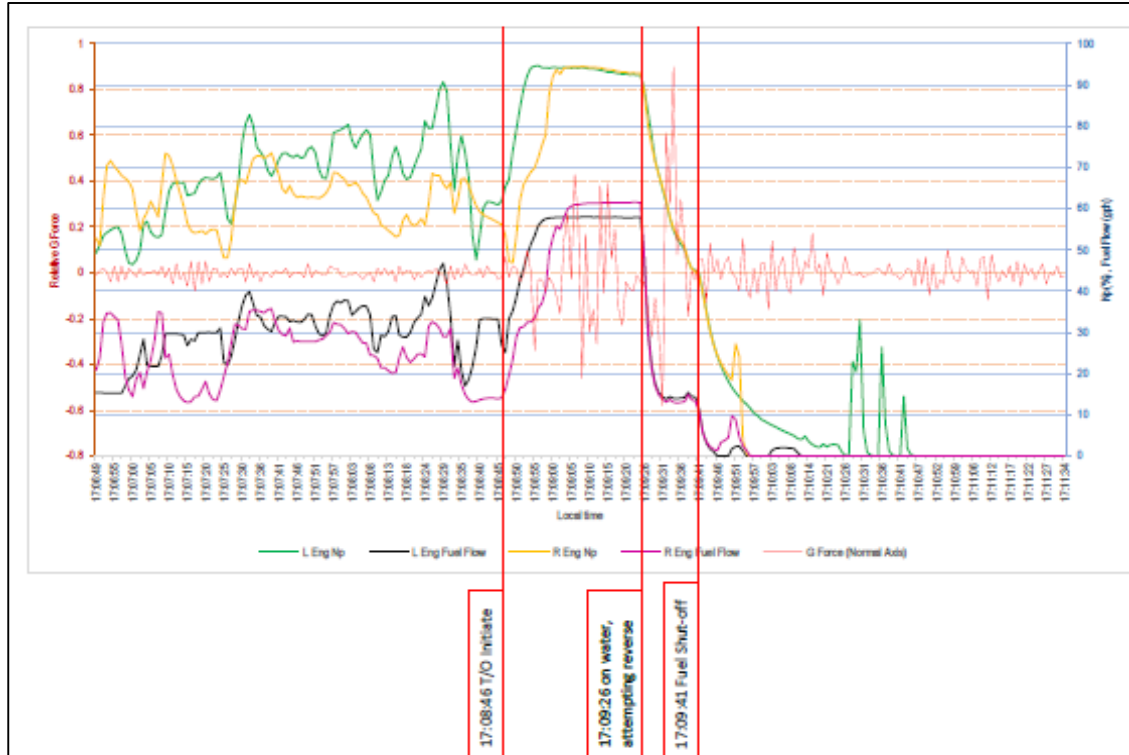

b. (IAS, G Force, GPS Alt)

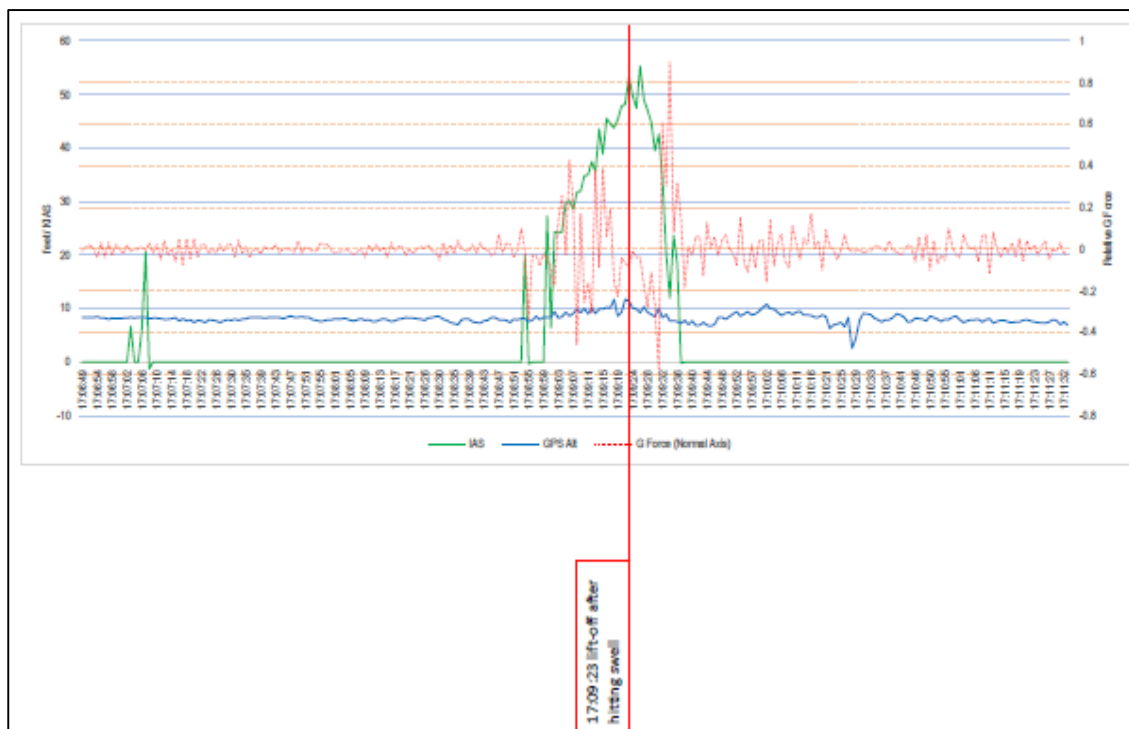

4.4 Finolhu Water Aerodrome Chart

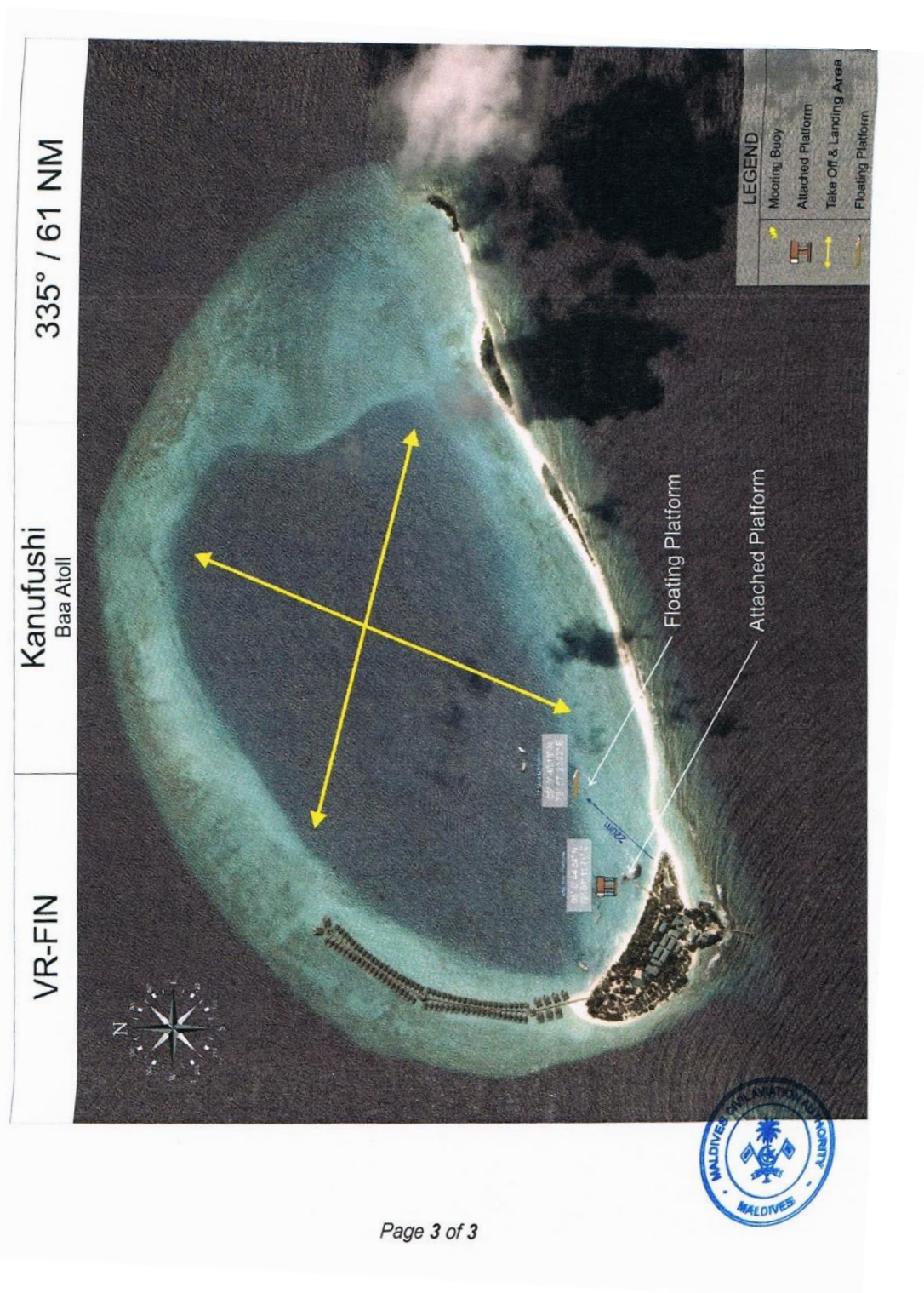

4.5 Damages to aircraft and the bungalows

The below photos show the damages to both the aircraft and the bungalows:

5.0



Figure 9: Left Wing Aircraft 8Q-MBC



Figure 10: Damage to LH wing



Figure 11: Damages to Right Wing



Figure 12: Damage left wingtip fairing



Figure 13: Damages to jetty of water bungalow



Figure 14: Damages to water bungalow



Figure 15: Damages to jetty of water bungalow



Figure 16: Damages to jetty of water bungalow



Figure 17: Damages to jetty of water bungalow



Figure 18: Damages to jetty of water bungalow

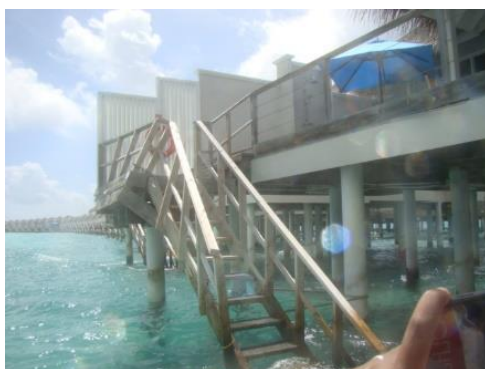

Figure 19: Damages to jetty of water bungalow



Figure 20: Damages to jetty of water bungalow

4.6 Still pics – in sequence; captured from the Video at the time aircraft came in contact with the bungalow



1



2



3



4



5



6